

| | |
|----------|--------|
| ITEM NO: | REMARK |
| CPV007 | |

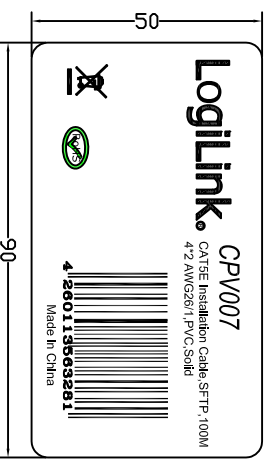
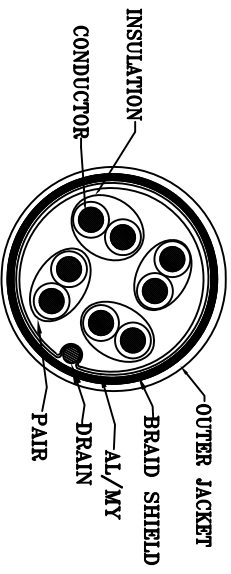
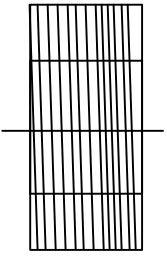
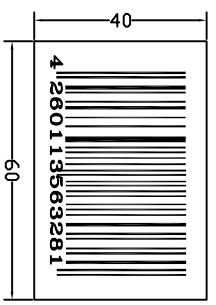
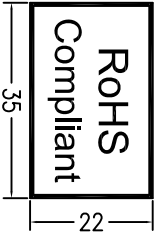
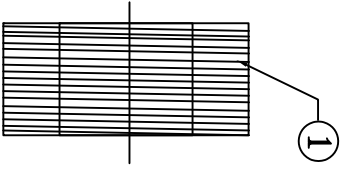
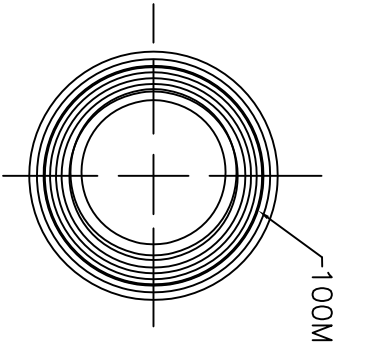

- NOTES:
- 1) CABLE LENGTH:100M
 - 2) EASY PULL WHITE BOX
 - 3) IPC 50*90MM Sticker on both sides of white box
 - 4) IPC 40*60MM EAN label on shipping mark of outer carton
 - 5) ROHS label stick next to EAN label
 - 6) CABLE with ROHS compliant

CABLE:
 1) CAT.5E SFTP 26#4P(1/0.45)CCA, AL/MY+D.W.+ Braid 30%, SOLID TYPE OD:6.2MM
 LIGHT GRAY(3014), 100M/ROLL (ROHS)
 CABLE PRINTER:SFTP CAT.5e NETWORKING INSTALLATION CABLE AWG 26/1*4P

| | | | |
|---------------------|---------------|---------|---------------|
| A | FIRST EDITION | | |
| REV | DESCRIPTION | DR | DATE |
| 2DIRECT GMBH | | | |
| TITLE | | P/N | CPV007 |
| SFTP CABLE(ROHS) | | DR | gmlc 04/10/07 |
| Drawing no: 0263 | | UNIT:MM | |
| CHKD: | APPD: | CONF: | |
| | | SIZE:A4 | |